

THE ILLUSTRATED STORY OF

THE  
**ATOM  
BOMB**

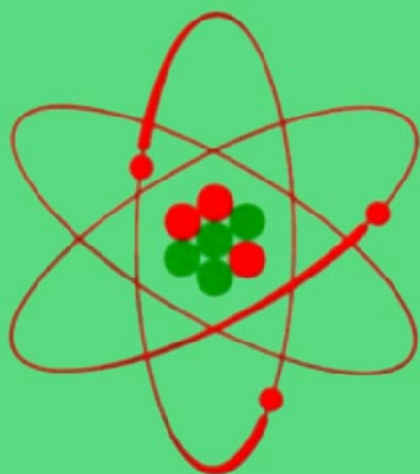

To add to your enjoyment of THE ILLUSTRATED STORY OF THE ATOM BOMB, we have designed maps of many of the locations mentioned in the book. Refer to the maps as you read the story, and you will gain an even greater knowledge of the history of the atom bomb.



*Quest For Knowledge Series*

# LEGEND

- Normal connection
- Connection requiring special equipment or problem solving
- One-way connection
- One-way connection requiring special equipment or problem solving

Ω

OMEGA -  
last letter in the  
Greek Alphabet

♎

LIBRA -  
constellation of  
the Balance

♿

MERCURY -  
swift messenger  
of the Roman  
Gods

♂

MARS -  
Roman God of  
War

♇

PLUTO -  
Greek God of  
the Underworld

α

ALPHA -  
first letter of the  
Greek Alphabet

♆

NEPTUNE -  
Roman God of  
the Sea



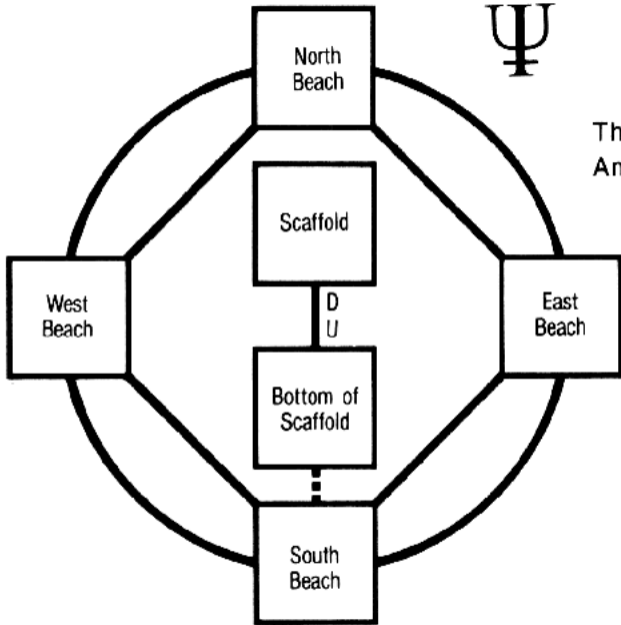

The Eniwetok ATOLL was the site of America's first H-bomb explosion.

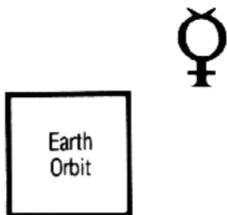

In the depths of OUTER SPACE, an orbiting "umbrella" of high technology defends the Free World from nuclear attacks.

Ω

Cliff  
Edge

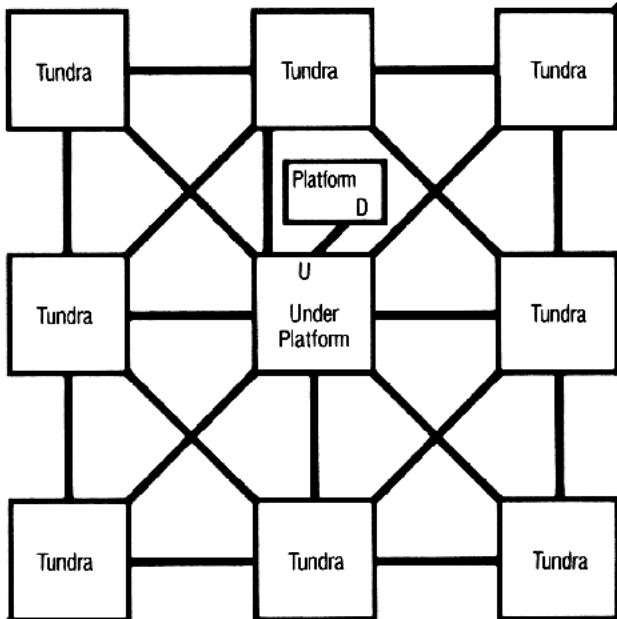

Control  
Bunkers

In the wastelands of **SIBERIA**, the Russians build and test their own atomic weapons.

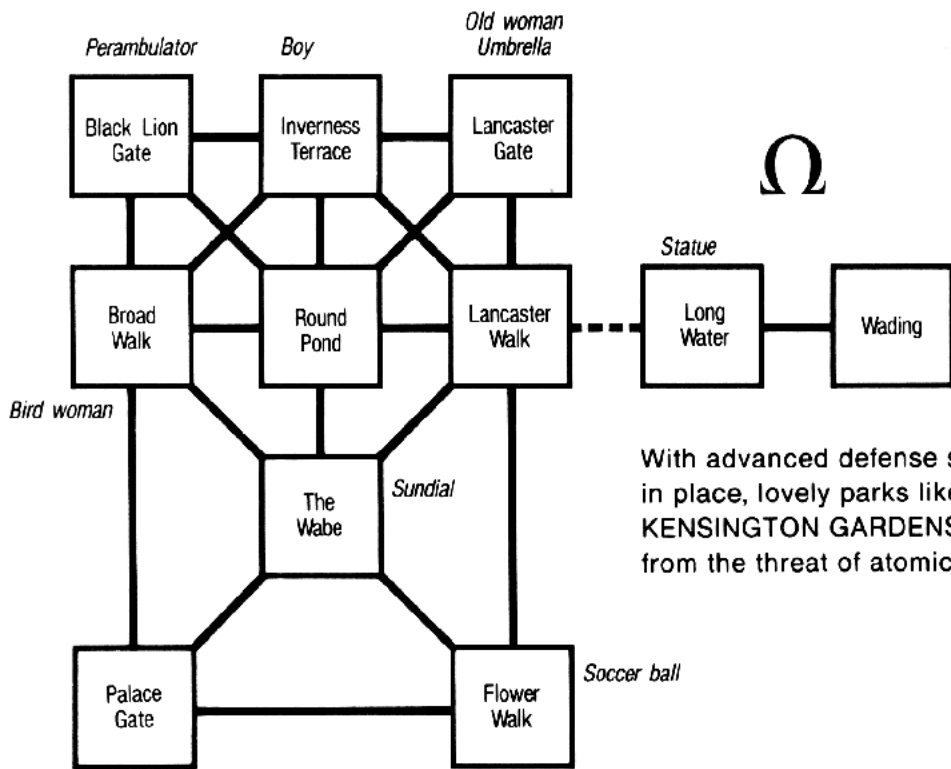

With advanced defense systems now in place, lovely parks like London's KENSINGTON GARDENS are safe from the threat of atomic war.

P

UNDERGROUND testing helps us to develop more and better nuclear weapons.

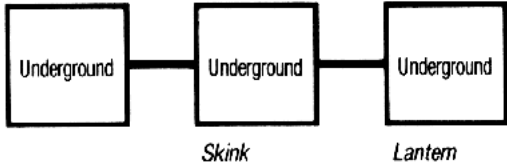



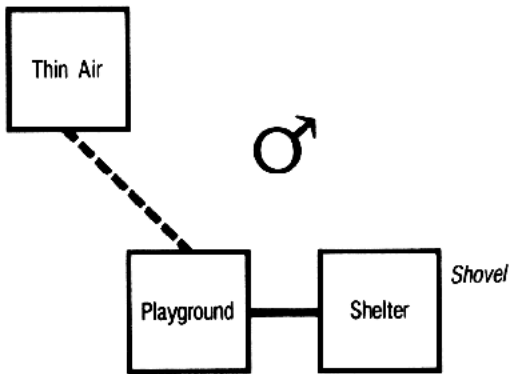

The bombing of the Japanese city of NAGASAKI brought World War II to an end.

The first atomic bomb was built and detonated at this site in the NEW MEXICO desert. A 100-foot steel tower was erected for the test (see map above right). Final assembly of the bomb took place in the nearby ranch house (see map to the left).

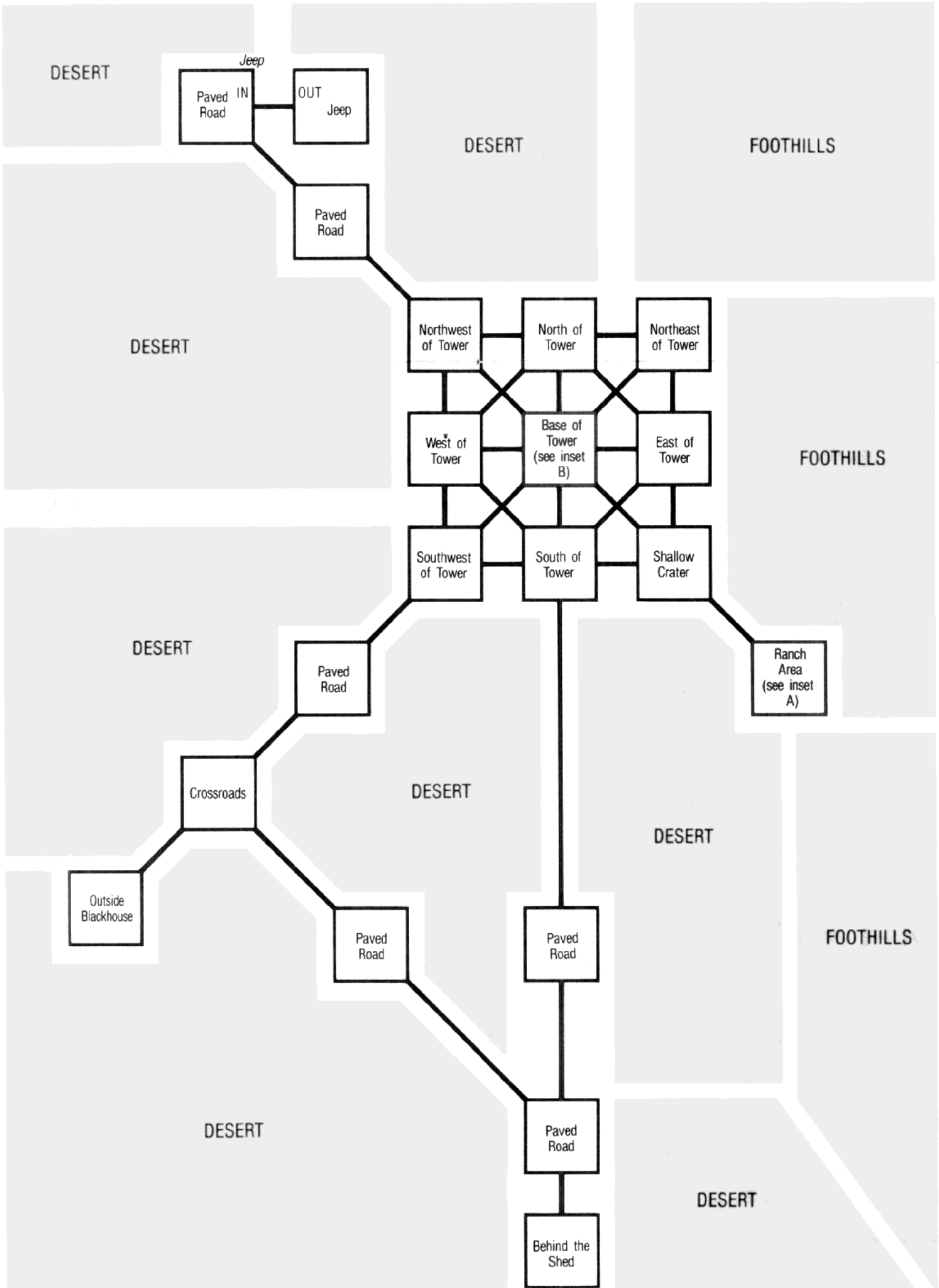



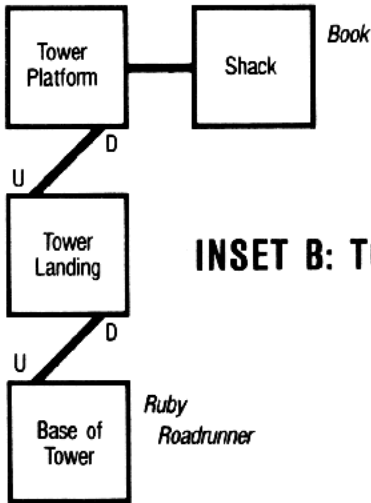

## INSET B: TOWER